



Grand Paris Express Line 16, Sevran Beauvois Station
Diaphragm Walls, Grouting, Jet grouting and bored Piles

Terratest

Terratest



TERRATEST

Presentation

Terratest is an International Construction Group, leader in Special Foundations, Soil Improvement, Microtunneling and the Environmental Sector. Founded in 1959, we are one of the few companies in the world covering the entire range of Geotechnical Works, so we are pleased to offer comprehensive solutions to geotechnical problems of any kind and magnitude.

The aim of our company is to provide suitable solutions to our clients, with seriousness and efficiency, adapting our knowledge and resources to the specifications of each project, and presenting more advantageous alternative solutions.



Picasso-Towers, Malaga.
Precast Piles and Ground Anchors





Desalination Plant Los Pelambres, Chile
2 Pipe Jacking drives with Hydrosield AVN 2000; AVN 1800





South of Texas - Tuxpan Pipeline, Altamira Landfall, Tamaulipas Mexico
Tunneling and Civil Works





Grand Paris Express Line 16
Diaphragm Walls, Grouting, Jet grouting and Bored Piles





Syncrolift yacht dock, Barcelona
Bored Piles



Terratest Network

Terratest has a strong international presence and is involved in many major projects carried out in the world. Our international team is ready to face future challenges and demonstrate the adaptability of our company to both developed and emerging markets.

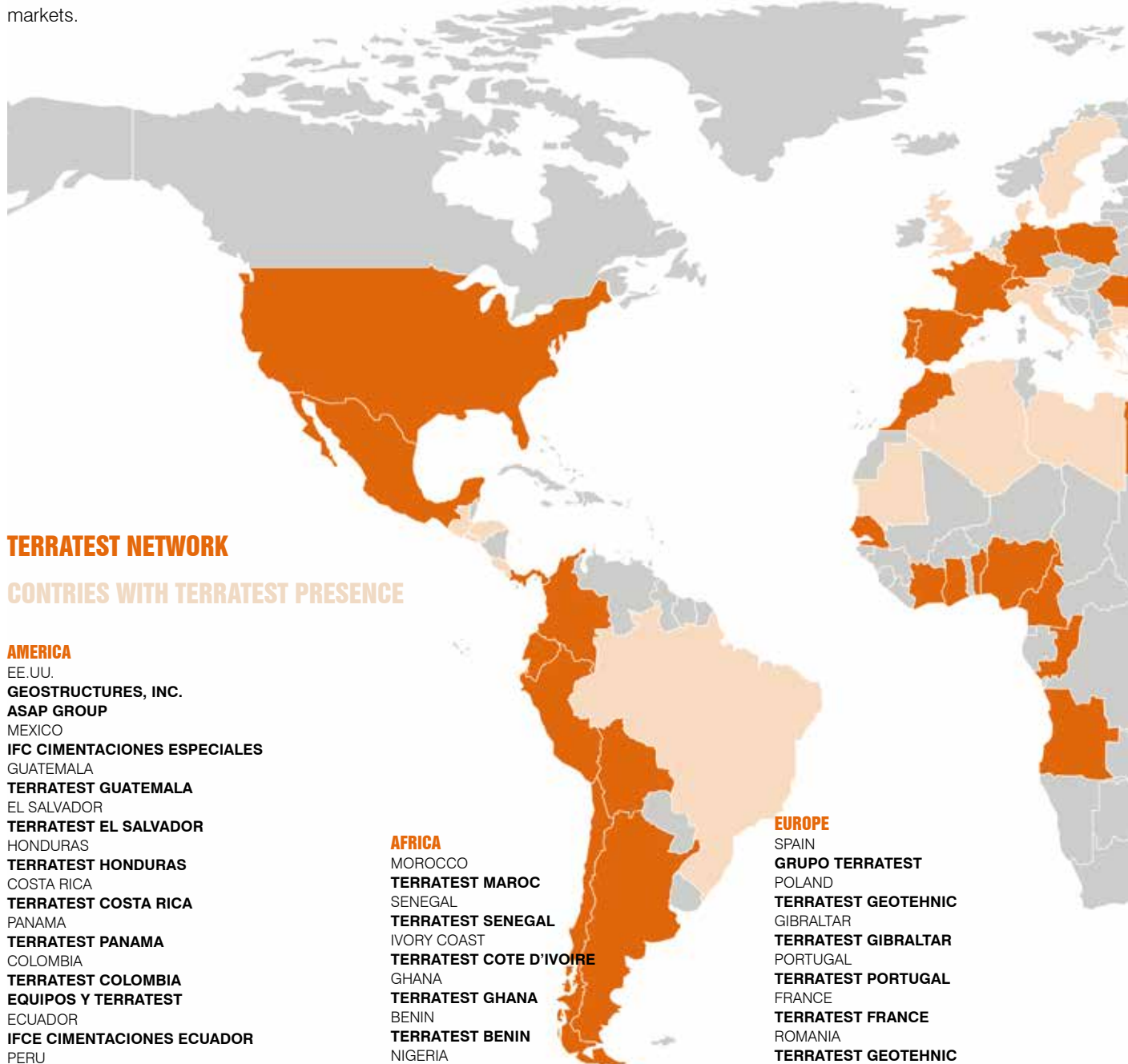

TERRATEST NETWORK

COUNTRIES WITH TERRATEST PRESENCE

AMERICA

EE.UU.
GEOSTRUCTURES, INC.
ASAP GROUP
 MEXICO
IFC CIMENTACIONES ESPECIALES
 GUATEMALA
TERRATEST GUATEMALA
 EL SALVADOR
TERRATEST EL SALVADOR
 HONDURAS
TERRATEST HONDURAS
 COSTA RICA
TERRATEST COSTA RICA
 PANAMA
TERRATEST PANAMA
 COLOMBIA
TERRATEST COLOMBIA
EQUIPOS Y TERRATEST
 ECUADOR
IFCE CIMENTACIONES ECUADOR
 PERU
CIMENTACIONES PREFABRI. TERRATEST PERU
 BOLIVIA
IFC BOLIVIA SRL
 BRAZIL
TERRATEST BRASIL
 ARGENTINA
TERRATEST ARGENTINA
 CHILE
GRUPO TERRATEST

AFRICA

MOROCCO
TERRATEST MAROC
 SENEGAL
TERRATEST SENEGAL
 IVORY COAST
TERRATEST COTE D'IVOIRE
 GHANA
TERRATEST GHANA
 BENIN
TERRATEST BENIN
 NIGERIA
TERRATEST FOUNDATIONS NIGERIA
 CAMEROON
TERRATEST CAMEROUN
 RÉPUBLIQUE DU CONGO
TERRATEST CENTRAL AFRICA
 ANGOLA
TERRATEST ANGOLA
 EGYPT
TTFT, LLC

EUROPE

SPAIN
GRUPO TERRATEST
 POLAND
TERRATEST GEOTEHNIC
 GIBRALTAR
TERRATEST GIBRALTAR
 PORTUGAL
TERRATEST PORTUGAL
 FRANCE
TERRATEST FRANCE
 ROMANIA
TERRATEST GEOTEHNIC
 SWITZERLAND
RODIO GEOTECHNIK AG
 GERMANY
RODIO GMBH SPEZIALTIEFBAU
MIDDLE EAST
 QATAR
TERRATEST QATAR
 BAHRAIN
TERRATEST BAHRAIN

Activities

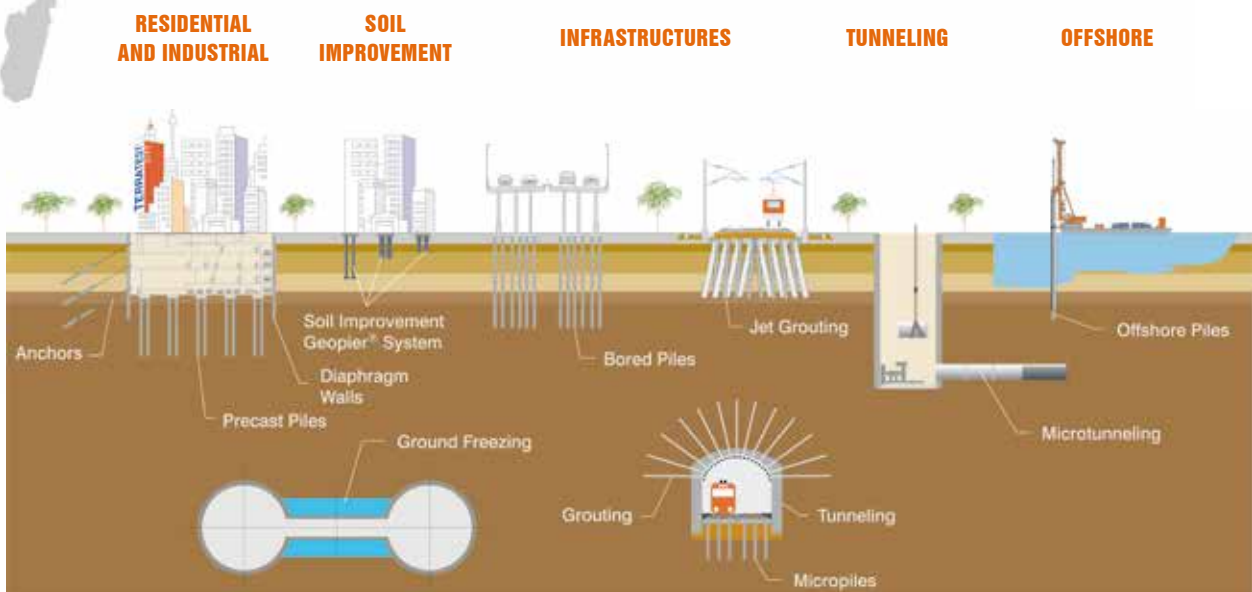
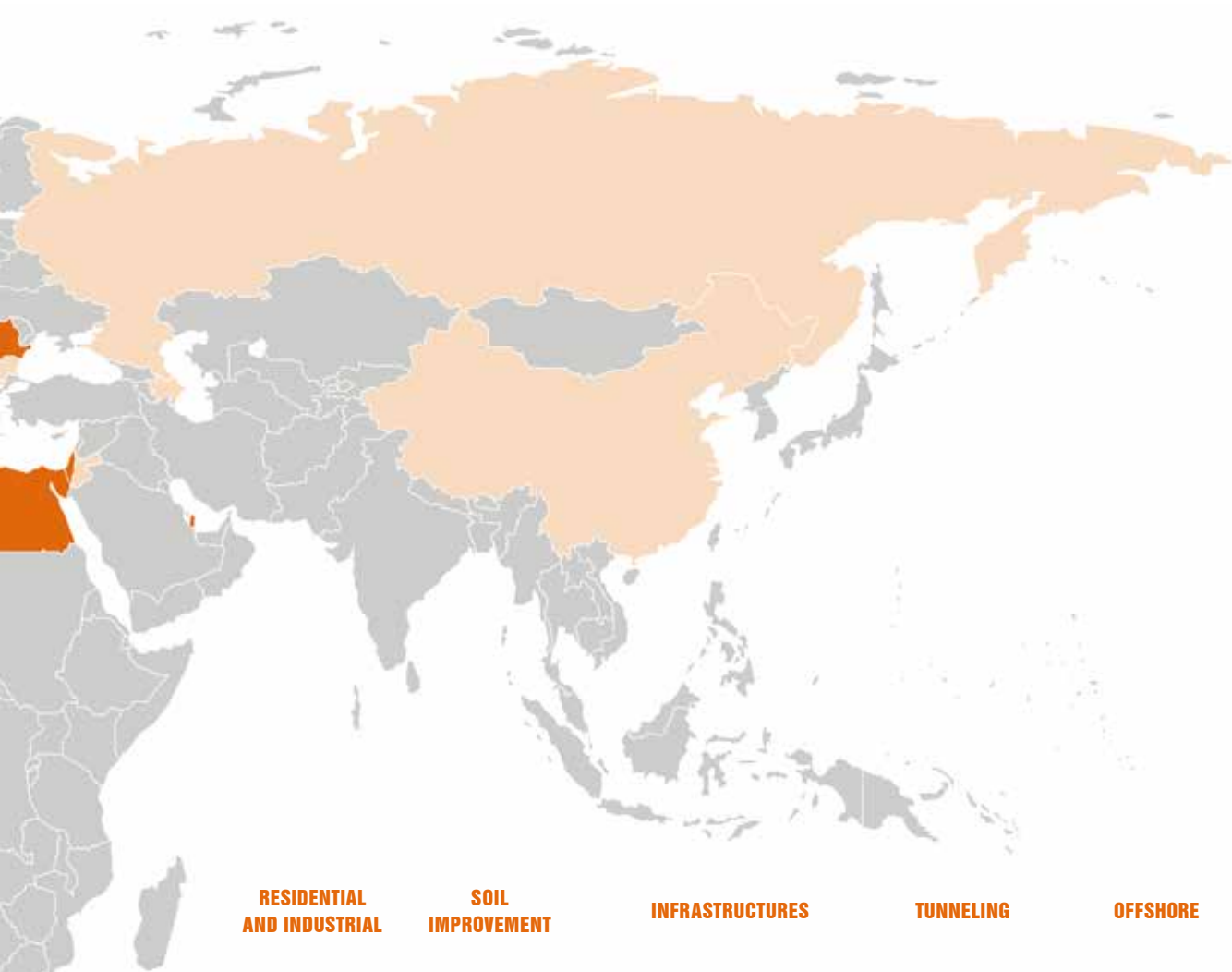



Paris Expo Porte de Versailles Convention Centre, France
Bored Piles

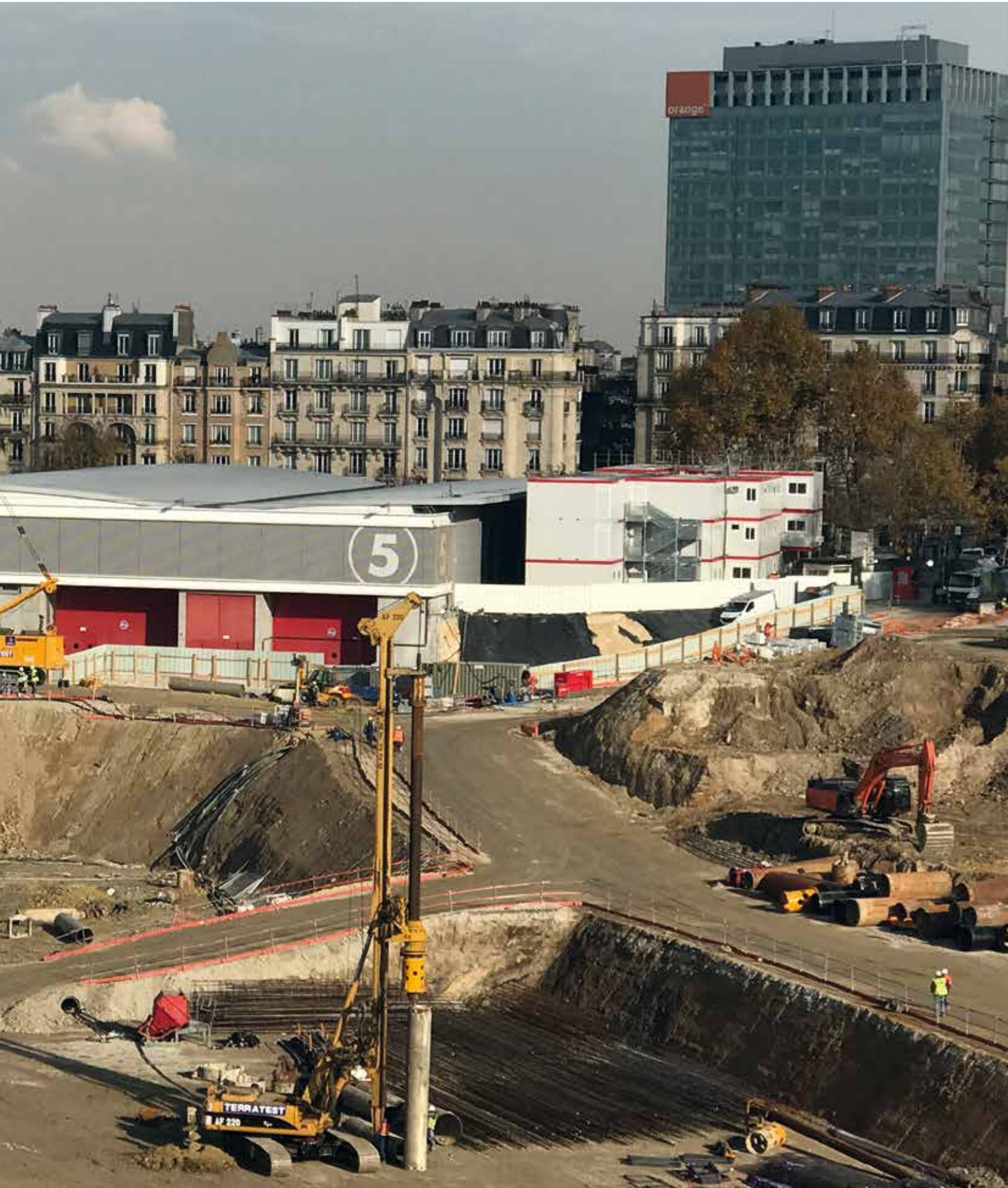

Activities

Piles

Bored piles



CFA



Precast Piles



Micropiles



Offshore Piles



Excavation Support

Diaphragm Walls



Trench Cutter



Soil Nailing



Ground Anchors



Sheetpiles / Metal Bracing



Ground Improvement

Stone Columns



Jet Grouting



Compensation and
Compaction Grouting



Wick Drains



Underpinning



Ground Improvement

GEOPIER® Systems



Rapid Impact Compaction (RIC)



Tunneling

Microtunneling



Consolidation



Environmental Works

Soil Decontamination



Water reservoirs (Dams)



Urban and Industrial Landfills



Geotechnical and environmental hydrogeology



Impoundments Waste



Ground Freezing



Engineering design

GRUPO TERRATEST has a technical department consisting of a multidisciplinary team of senior engineers, highly qualified with extensive experience in many fields, including geotechnical, structural calculations (metal and concrete) and of course special foundations.

The technical department of GRUPO TERRATEST uses specialist, last generation software, both in-house developed and acquired, which allows the best of both worlds for each project. Some of these programmes are: Plaxis, Rido, Cype, Ansys, etc. GRUPO TERRATEST's specialists are experts in the use of this software and they have years of experience in the field of geotechnics applied to special foundations.

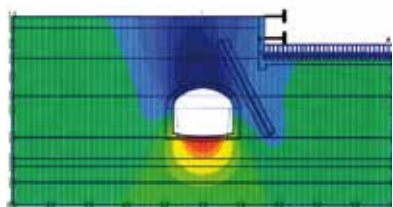

Activities

PILES

BORED PILES

Concept and characteristics

Extraction piles, bore-cast and concreted «in situ», constitute one of the classic foundation systems for problems arising from the land's support capacity or from the need to carry heavy loads transmitted by the structure to which the foundations are destined.

The pile diameters that can be achieved have no limitation, but generally vary progressively between 400 and 2500 mm. The depths that can be reached exceed 60 m.

Procedure

There are basically three phases in the procedure for a pile bored and concreted «in situ»:

- a) The bore
- b) Installation of reinforcement
- c) Concreting

The characteristics of the land (stratigraphy, water level, etc.) condition the bore type and system: dry rotation, rotation with recoverable casing, rotation with muds or polymersic mixtures and, finally, with and recoverable casing chissel&grab.

Applications

Bored piling is popular to be used in construction as a foundation, especially for bridge work and tall buildings as well. Usually bored pile is used for those tall buildings or massive industrial complexes, which require foundations that can bear the load of thousands of tons, most probably in unstable or difficult soil conditions.

Piles are also used to protect digging in the supporting of soil. Depending on the characteristics of the soil to be retained, they are set apart at a tangent and even secant piles.



Hydroelectric Power Plant El Tornillito, Honduras
Bored Piles

Nova Arquibancada da Marquês de Sapucaí . Rio de Janeiro/RJ. Brasil
CFA and Precast Piles

CFA

Concept and characteristics

The continuous auger bored piles belong to the category of bored piles with partial soil removal. Drilling is performed by means of a hollow, continuous auger.

This technique allows the production of piles with diameters varying from 300 to 1000 mm, for a maximum depth of 30 meters.

Procedure

A hollow auger is inserted into the ground once the necessary depth has been worked out, and then concrete is pumped down the hollow stem. At the same time, the hollow auger is withdrawn and, in order to reinforce the piling, a reinforced cage is used.

It is possible to monitor the entire installation process of the piles. A flow meter provides accurate data that is then recorded and can be analyzed. Information that is collected includes penetration/uplift per revolution, auger depth and injection of pressure at the head of the auger.

Applications

One of the benefits of CFA piles is that there is no casing involved and so there is minimal disruption associated with using them. They also help to keep vibrations to a minimum and can be used on large projects, making them a good piling solution for a range of situations.

CFA piles are a type of piling that is especially good for use on building sites where there is a need to keep noise to a minimum.



Clinker mil in Toledo, Spain
Precast Piles

Structure LAV Levante, Section Villena Sax, Alicante, Spain
Precast Piles

PRECAST PILES

Procedure

The piles are driven with modern, free-fall equipment, using a hammer of between 5 and 9 tons raised either by a simple cable system, or the most advanced hydraulic drive methods with high performance and controls. This equipment is completely autonomous (requiring no auxiliary components) and mounted on crawler-cranes for easy movement.

Precast square elements are joint together with special keys (ABB seal) designed by Terratest technical department. The ABB seal is the element allowing the union of different pile sections, to reach the necessary depth. These seals are made with high-quality materials, and calculated to bear greater stresses even that the pile's standard section, as demonstrated in bending, compression and traction trials.

**Pre-cast Reinforced Concrete Piles
 Technical Specifications**

GEOMETRICAL DATA AND DETAILS	Pile Type	T-200	T-235	T-270	T-300	T-350	T-400			T-450	
	Pile lenght or Pile sections	Variable between 3 and 15 meters									
	Nominal section (cm²)	400	552	729	900	1225	1600			2025	
	Squared section Pile side (mm)	200	235	270	300	350	400	400	400	450	
	Longitudinal reinforcement	4Ø12	4Ø16	4Ø16	4Ø20	4Ø20	4x2Ø16 2Ø16	4x2Ø20 2Ø20	4x2Ø25 2Ø25	8Ø25	
	Transversal reinforcement	Ø6 19,6 cm	Ø6 17,2 cm	Ø6 15,2 cm	Ø6 13,7 cm	Ø6 11,8 cm	Ø6 10,0 cm	Ø6 10,0 cm	Ø8 10,0 cm	Ø8 8,50 cm	
	Structural capacity	61, 7 Tn	84,8 Tn	112 Tn	137,9 Tn	187,7 Tn	244,8 Tn	244,8 Tn	244,8 Tn	303,7 Tn	

Applications

Precast piles Applications

Precast piles are especially utilised for their low cost advantages, for sites in remote areas and for foundations with contained vertical loads applied.

Precast prestressed piles Applications

Because of the initial prestress force, TERRA's precast prestressed piles are particularly indicated for the absorption of traction and bending strains, and horizontal thrust, giving foundations which are more economical than other designs.

The following may be highlighted, among other applications:

- Structures (bridges and viaducts).
- Tall buildings or those situated in earthquake zones.
- Structures and buildings where the ground floor or basement levels are below the water table.
- Contention of walls, basements, etc.
- Industrial buildings with significant horizontal or bending stresses.



MICROPILES

Concept and characteristics

Micropiles are small diameter cylindrical holes (between 114 and 400mm), into which a tubular metal frame is introduced, normally with a high elasticity limit (also bar reinforcement is used). It is joined to the ground by the means of a pressure injection of cement grout or mortar.

Procedure

1. BORING

The technique used to bore for a micropile depends basically on the type of land involved. While there are several boring procedures, the following are the most used:

- OD.
- ODEX.
- Rotation.
- Hammer rotopercussion at the head.

Although it is not necessary in some cases to protect the bore against internal land collapse, it is usual to use recoverable casing, and sweeps with water and compressed air. If the land is not stable for boring, it may be necessary to use waste tubing, which can substitute for or complement the reinforcing required. The bore is washed with water and/or pressurised air. If the reinforcement is tubular, which is the most-used, it goes into the bore once the washing is finished. Bar reinforcing is introduced once the bore is grouted.

2. GROUTING

Grouting is done using the reverse circulation pumping technique for the cement or mortar.

For tubular reinforcement, pumping is done through the tube, to the bottom of the bore, then up through the annular space formed between it and the land, shifting the bore detritus with it. If the tubing is itself the reinforcement, grouting is done following bore cleaning. If a bar, it is grouted following washing, and the bar is introduced immediately afterward.

Applications

The applications are many, most particularly in all types of work involving reduced space or where large machines are not possible because of their excessive weight:

- Rehabilitation of all types of buildings.
- Underpinning.
- Foundation reinforcement in building extensions.
- Deep foundations on small plots.
- Support for existing foundations for basement excavation.
- Slurry walls in reduced spaces.
- Slope stabilisation on roads.
- Fore-piling for tunnel openings.
- Deep foundations on land not suitable for conventional piling.



Excavation pit in Almeria, Spain
Micropiles

Shopping mall El Corte Inglés. Albacete, Spain
Diaphragm walls

EXCAVATION SUPPORT

DIAPHRAGM WALLS

Concept and characteristics

Continuous reinforced concrete core walls are vertical walls made in spans of up to 7 metres in length and thicknesses between 0.40 and 1.50 metres, and depths of up to 70 m, and offer a solution to excavation difficulties in urban areas or around the water table level.

Procedure

To install diaphragm walls in the ground, mechanically-driven grab buckets are used with weight ratings of between 5 and 23 Tons and grab openings of between 2.60 and 4.20 metres. The grab will start the excavation to the projected depth, normally with the help of bentonite slurries. These liquids, of variable density (and whose principle component is bentonite) allow the excavation to be completed cleanly and do not trigger landslides from the surrounding walls. The bentonite can be introduced into the excavation cavity by pumps from storage tanks.

Once the foundation trench is excavated (the name given to the hole from the depth and maximum aperture of the hydraulic grab, cable or rotary to the hole to be filled with thixotropic cement) the steel support indicated in the framework and cutting plans is introduced, then the concrete is poured through an elephant trunk system, consisting of a bell type tongue and groove system (tremie pipe). With the help of excavation or other auxiliary equipment the framework is introduced and concreted whilst the excavation begins on the next trench. These steps are repeated successively until



Sant Ponz pit. Gerona, Spain
Trench Cutter

the completion of the diaphragm walls around the perimeter of the site.

Applications

They are used in a large number of projects (bearing structures, provisional or definitive retaining walls, etc.) and represent a solution to different problems such as the excavation of buried structures such as underground car parks and basements, subways, etc., to the creation of subsoil waterproofing in loose material dams.

TRENCH CUTTER

Terratest is one of the world leaders in the execution of Diaphragm walls with Trench Cutter. A Trench Cutter is a reverse circulation excavation machine, consisting of a heavy steel frame and two cutting wheels attached to its bottom end. The wheels rotate in opposite directions around horizontal axes, breaking the soil beneath the cutter and pumping it out of the trench to a complex desanding plant.

The Trench Cutter is utilized:

- For the excavation of hard rock formation
- For large thickness and depths
- And when high accuracy is required

New High-speed railway station.
Gerona, Spain
Diaphragm walls, Bored Piles,
Trench Cutter



Car park in Portugalete Square. Valladolid, Spain

Ground Anchors

Car park in Torrelavega Avenue. Asturias, Spain

Metallic Bracing

SUPPORTS

Diaphragm walls can be free standing, or together with others, which can work as a cantilever. This solution needs a recess depth of the large wall and high quantities of steel. This makes it necessary to study solutions that provide support to the wall during the excavation and reduce forces and deformations to the wall.

The type of bracing most commonly used is that completed through ground anchors, which facilitate the construction of slabs. However, for economic reasons or influenced by the construction process, other varieties of bracing exist, among them:

- Anchors
- Metallic bracing.
- Anchors + metallic bracing.

GROUND ANCHORS

Ground anchors (both temporary and permanent) are a technically and economically competitive solution, because they facilitate the process of bracing and reduce the execution time of the works, providing a high level of security thanks to the technical development experienced in recent decades. Ground anchors are principally designed to absorb tensile forces. To perform this task, the anchors are divided into four parts:

- The bulb: transmits traction to the ground via its shaft that induce tension.
 - The free extension zone: situated between the anchorage zone and the head of the anchor, and where no forces are transmitted to the surrounding ground allowing the bulb to be situated in stable ground levels, outside of areas of slippage.
 - The anchor head: that connects the structure (mainly Diaphragm walls) and must fully absorb the tension of the reinforcement.
 - Anchor reinforcement: transmits the tension from the head to the bulb, passing through the free extension zone.
- Some of the applications of ground anchors are as follows:
- Bracing of retaining structures.
 - Diaphragm walls.
 - Curtain walls of piles.
 - Walls constructed by foundation trench in descending phases.
 - Micropile walls.
 - Sheath piling.
 - Stabilisation of slopes

METAL BRACING

The scope of use of the TERRATEST metal bracing system includes any type of work (building and public works) in which a Diaphragm walls, of any type (continuous, pile or micropile) is to be constructed, and in which metal bracing is feasible geometrically.

TERRATEST is able to offer its customers a metal bracing system designed to measure, and meet their needs from a technical and economic standpoint, and in addition, provide technical advisory services at the highest level.

SHEETPILES

Sheet piling is an earth retention and excavation support technique that retains soil, using steel sheet sections with interlocking edges. Sheet piles are installed in sequence to design depth along the planned excavation perimeter or seawall alignment. The interlocked sheet piles form a wall for permanent or temporary lateral earth support with reduced groundwater inflow. Anchors can be included to provide additional lateral support if required.

Terratest Group supplies and installs vibratory-driven sheet piles for both permanent structures and temporary retaining walls or construction pits. The possible applications vary greatly, depending on whether the work will take place on land, on the water or along a railroad.

Sheet pile walls have been used to support excavations for below grade parking structures, basements, pump houses, and foundations, construct cofferdams, and to construct seawalls and bulkheads. Permanent steel sheet piles are designed to provide a long service life.



Somport Tunnel. Huesca, Spain
Ground Anchors

SOIL NAILING

Soil nailing is a technique used to bring soil stability in areas where landslides might be a problem. Soil nail can prevent landslides by inserting steel reinforcement bars into the soil and anchoring them to the soil strata. It is called Soil Nail, because it's like having a nail being hammered into the soil, where the nails, are the steel bars.

Procedure

Its construction process is faster than other similar methods. The construction procedure starts, drilling into the soil, where the nail, steel bar, is going to be placed. After the drilling has been completed, exact depth must be provided by the geotechnical engineer, the nail must be inserted into the drilled hole. Then, it must be grouted into the soil to create a structure similar to a gravity wall. After placing the nail, a shot-Crete layer is usually placed as a facing material, to protect the exposed nail, and then other architectural options are placed over the shot-Crete, creating an aesthetic finish to the project.

Soil Nailing is not recommended to use on clayey soils, and or clean sands where the cohesion of the soil is minimum.



Landslide in Bonares. Huelva, Spain
Soil Nailing

GROUND IMPROVEMENT

STONE COLUMNS

Concept and characteristics

As a general rule, stone columns are executed with a vibrator with lower discharge and a discharge chamber and an extension feed tube on the top. Thanks to the feed tube and the compressed air, the gravel is pushed to the end. For this special equipment, Terratest has created a guide frame that enables driving and lifts the vibrator, the gravel then falling into the outlet hole. The vibrator then drops back down into the gravel, compacts it and expands sideways against the soil. The columns produced in this way bring together the essential loads to be withstood.

Geotechnical aspects

Unlike vibro-compaction, an improvement in compactness between columns is not initially considered, although it does arise in some cases. The improvement lies in the extremely elastic flexible module inclusions, without cohesion, which have an improved supporting capacity to decrease and control settlements.

Procedure

1. Preparation

The machine is positioned over the drive point and stabilised on the skids. A loader supplies the gravel.

2. Filling

The contents of the hopper are poured into the tube. On closing it, the compressed air allows for a continuous flow of gravel to the outlet hole.

3. Driving

The vibrator descends, moving the soil sideways, to the planned depth thanks to the compressed air and the static drive of the unit.

4. Compaction

When the final depth is reached, the vibrator is lifted slightly and the gravel takes up the freed space. The vibrator is then lowered again to expand the gravel sideways against the soil and compact it.

5. Finish

The column is produced in this manner on successive drives up to the planned level. The foundation footings are then executed directly in the traditional manner.

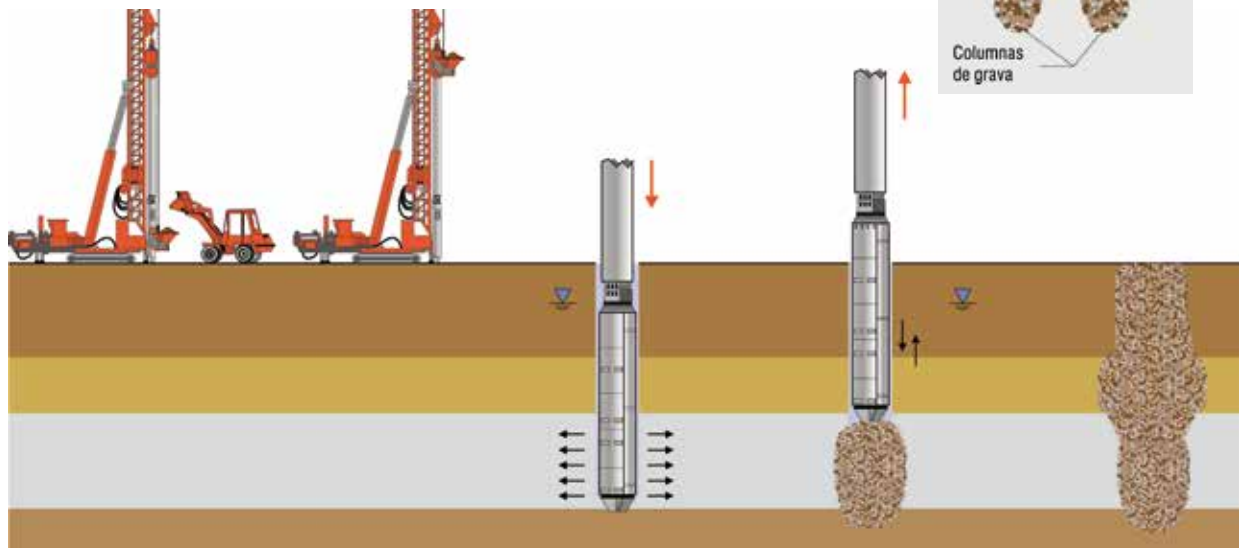
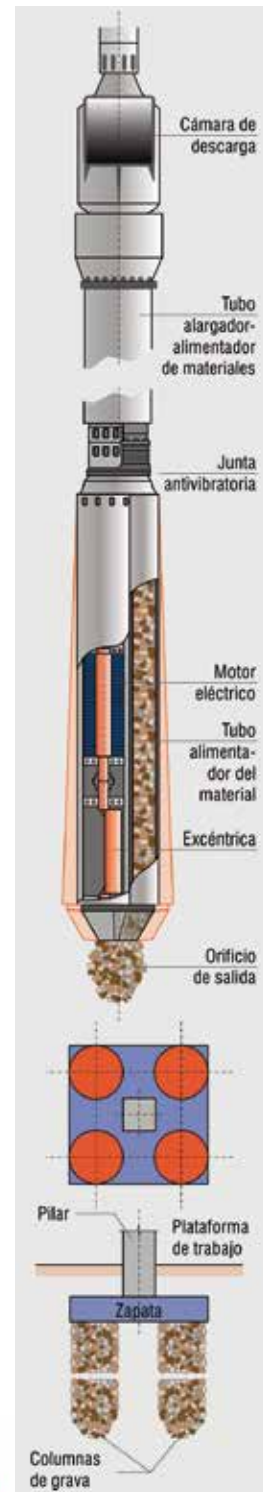

Zurich Airport, Switzerland
Jet Grouting

JET GROUTING

The Jet Grouting process

The Jet Grouting process or Soilcrete is known as a soil-cement stabilisation.

The soil around the bore is eroded with the aid of a high-pressure jet of water or cement suspension with a nozzle output speed 100 m/sec (possibly airborne).

The eroded soil is rearranged and mixed in the cement suspension. The soil-cement mix is partly ejected into the annular space between the Jet Grouting rod and the bore. Different geometric configurations of Soilcrete elements are possible. The jet erosion distance varies according to the soil type and jet fluids used, and can reach diameters of up to 5 metres.

The Advantages of Jet Grouting

- Applicable to almost all soil types
- Individualised in situ treatment
- Designable strength and permeability
- Specific layer treatment
- Inert components only
- Vibration-free
- Applicable in limited working spaces
- Possibility of different Soilcrete elements
- Maintenance-free
- The safest and most direct underpinning method
- Able to operate around underground installations in service
- Faster than alternative methods

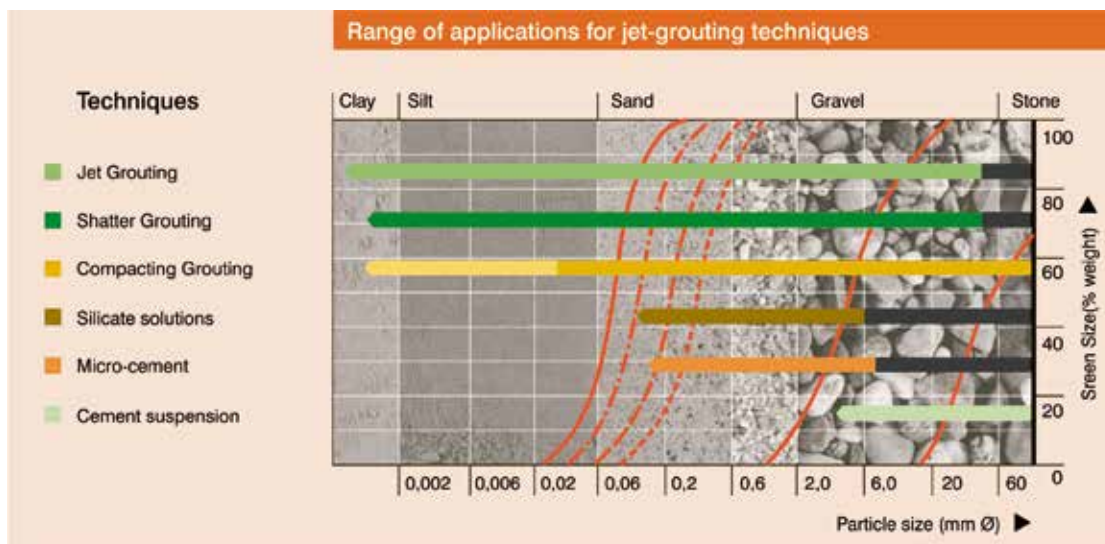

COMPENSATION GROUTING

Concept and characteristics

By using this process, fractures are created in the soil that are subsequently filled with cement grouting. Any formation in the soil can be improved by grouting and may controlled.

Procedure

1. Installation of the hose and inserting of the sheath

The hose is fitted into the bore hole drilled, filling the annular space between the bore hole wall and the hose pipe with a bentonite-cement mixture.

2. Soil breakage

In order to inject the suspension, a double shutter is inserted that separates each of the hose pipes during grouting.

3. Multiple grouting

The hose pipes can be inserted one or several times, depending on the technical requirements. The volume of grouting, the maximum grouting pressure and, in the case of repetitive grouting, the grouting speed are kept in line with instructions. The hoses pipes can be reused.

Applications

Restoring foundations

The footing and subsoils form part of the foundations of a structure. Over time, both can fail for different reasons. This is often the case in historic buildings.

In the case of excessive settlements, compensation grouting is a suitable process for restoring the link between the base of the structure and the supporting soil.

Elevating Structures

The settlement of structures can be solved using the compensation grouting. Depending on the condition of the building and the soil, the speed of elevation can be adapted to each case.

Partial and precise elevation within the range of millimetres is combined and added to total elevation within a range of decimetres, without damaging the structure. Structures are normally lifted without impeding their use.

Protecting Structures

To protect structures from foreseeable settlement during the construction of a tunnel, ranges of horizontal hoses are to be installed from temporary shafts between the tunnel vault and the foundations of the building. The building to be protected will be fitted with an electronic measuring system to record vertical movements.

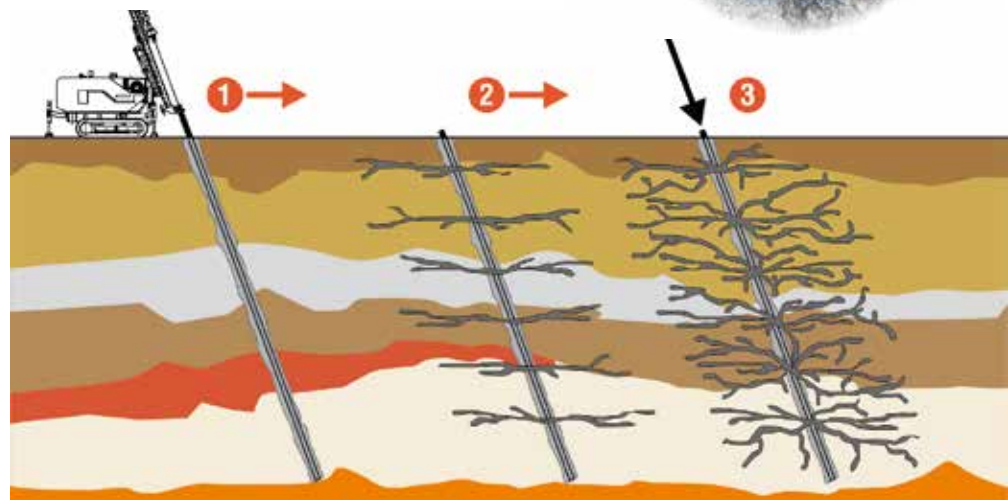
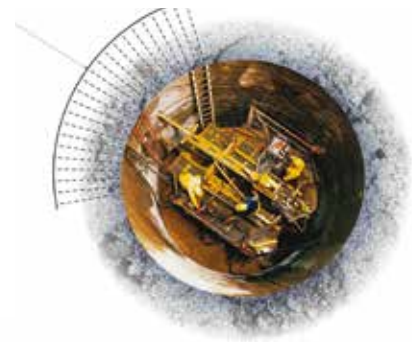

Installation point

COMPACTION GROUTING

The method of Static Grouting is based on the injecting of a low mobility mortar into the soil so that the injected mixture does not flow through the soil and remains concentrated around the injection point. This mortar is injected at a pressure of up to 40 bar and with a settlement on the Abrams cone of less than 8 cm, allowing for correct densification. The injected material fills the gaps and compacts or stabilises the soil surrounding the area treated. The mortar cement then sets to give it resistance and hardness. The soil must be displaced during injection without breaking its structure.

1. Installation of the grouting piping

The boring is drilled using rotary or rotary-percussion equipment depending on the characteristics of the soil.

2. Compaction Grouting

The mortar is prepared in the mixer and injected by pressure into the soil using a specific pump for this type of work. Meanwhile, the grouting piping is gradually inserted or withdrawn, creating a column made up of almost round bulbs that join together.

3. Compaction by phases

To ensure uniform soil compaction, grouting is worked onto a primary and then a secondary mesh. In the case of localised treatment, the grouting is worked at the points and with the gradients defined by the calculation.

Applications of Compaction Grouting. Types

Soil improvement

Improvement of soil with low supporting capacity, increasing its relative density. Compacting of non-cohesive soils, especially those with low or medium density with alternating hard or cemented layers. It can be used as an alternative or in addition to pile foundations or soil improvements using gravel columns.

Foundation stabilising and underpinning

Increasing or restoring the supporting capacity of the soil underneath existing foundations, e.g. in the event of an increase in excess load or to repair damage produced by settlements. This technical is an alternative to the Jet Grouting procedure and/or can be used as a preliminary treatment to apply Jet Grouting and Fracturation Grouting. Recovery of or increase in the supporting capacity along the shaft or the point of existing deep foundations.

Cavity filling

In very porous, eroded soils or those with cavities, e.g. in landfill areas that have not been sufficiently compacted, areas affected by karstification, soil damaged by the breakage of water pipes, etc.

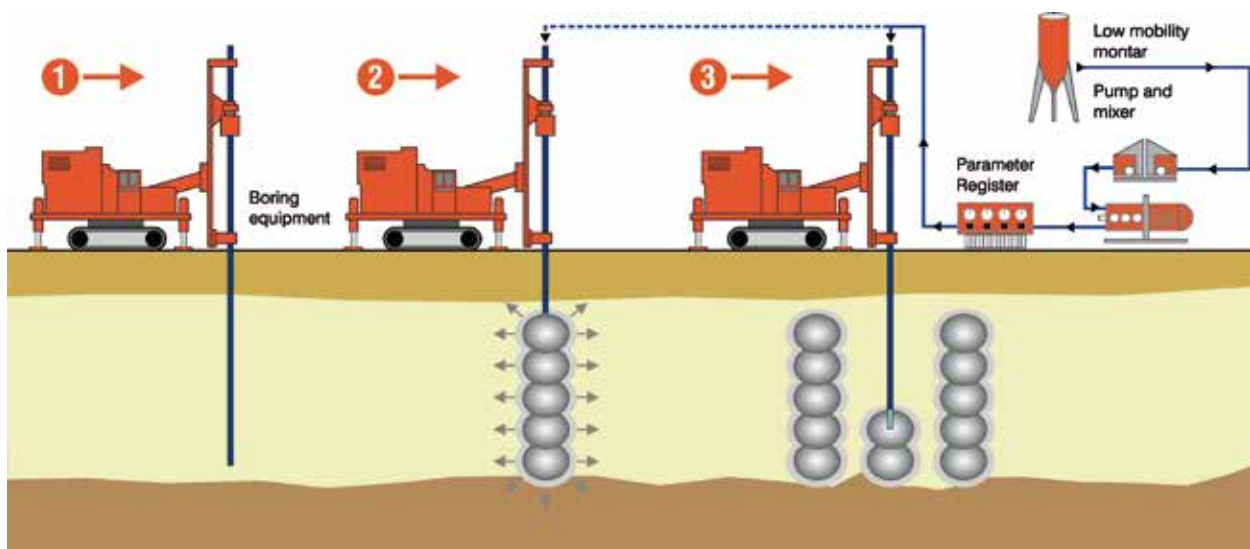

WICK DRAINS

The construction of a new embankment or structure induces additional stresses on the ground that can create unacceptable long term settlements during the life of an embankment or structure. A preloading programme can be designed to induce these settlements in an accelerated time frame and minimise the long term residual settlements to be within acceptable limits.

Fine grained soils such as Clays and Silts are usually saturated and therefore, settlements can only occur if the excess water is expelled through the voids in the soil grains and particles. These soils also tend to have a low permeability, and so the reduction of pore water pressure can be a slow process.

Vertical drains consist of a flat or cylindrical plastic core

wrapped in a geotechnical fabric, and allow water to drain up through the centre of the drain. These come in a variety of sizes and shapes to meet a variety of soil and site conditions.

Vertical drains can be used to increase the rate of consolidation, delivering substantial programme savings for the build times of earth embankments for many types of land raising schemes.

Prefabricated vertical drains are installed by pushing a hollow steel mandrel, which house the drain material, and are set out on a grid pattern.

The mandrel is driven into the ground by the rig, once at the required depth the mandrel is removed, leaving the vertical drain anchored by a steel anchor plate that holds the drain securely in place.



1. Car Park for "Max Center" Mall in Maliaño, Cantabria, Spain
Wick Drains
2. Crevillente-Torrevieja Ring Road, Spain
Wick Drains



GEOPIER® SYSTEMS

GEOPIER® soil reinforcement and improvement solutions are intermediate foundation techniques that are alternatives to the traditional solutions of excavation and soil replacement, structural fillings, foundation shafts and preloads, which take a long time to achieve their effectiveness. They are the result of continuous development and research to provide foundation and settlement control solutions on soft and compressible cohesive soils.

GEOPIER® systems provide significant increases in the permissible soils bearing capacity or limit the settlement of supported structures in accordance with project requirements. They are constructed by replacing and/or displacing the soil in successive compacted layers of gravel aggregates using specially patented tools to apply high vertical compaction energy, high frequency and low impact amplitude, thus achieving high internal friction angles ($>50^\circ$) in the compacted aggregate and higher rigidity modules than those obtained with vibration techniques.

The action of vertical compaction increases the lateral pressure and improves the capacity and shear resistance of the surrounding soils, resulting in an over-consolidation of the soil around each Geopier, which together with the high rigidity of the element allows effective settlement control.

For very low stiff and highly compressible soils, where the lateral tension is not sufficient to contain the compacted aggregate column, rigid inclusions solutions have been developed using very high modulus of stiffness elements for settlement control, based on the use of cement/concrete mixtures.

In all cases, GEOPIER systems make it possible to reduce execution times; they are quick and safe solutions with high quality control, the results of which are verified with static load tests to check the column rigidity module and guarantee the settlement estimated. The success of the system is supported by the thousands of projects carried out around the world over more than 30 years.



1. Storage Building, San Fernando (Cádiz)
Precast Piles, GEOPIER® Systems, Geo-Concrete Columns
2. Logistic Storage Warehouse. Cabezuela Dock. Puerto Real (Cádiz)
GEOPIER® Systems



RAPID IMPACT COMPACTION (RIC)

The Rapid Impact Compaction was originally developed in the early 1990's by B.S.P. in conjunction with the British Military as a means of quickly repairing damaged aircraft runways. Dynamic energy is imparted by a 9 ton weight dropping from a controlled height onto a patented foot. Energy is transferred to the ground safely and efficiently as the RIC's foot remains in contact with the ground. No flying debris is ejected. RIC densifies loose fill soils up to 20 feet deep or more. The benefit from the rapid compaction is it increases the bearing capacity of the soil, minimizes settlement and provides uniform support for a floor slab or foundation footing, while controlling vibrations to 2 inches per second within 30 feet of the drop point. RIC is a great alternative when compared to the time and cost of over-excavation and re-compaction.

The energy transmitted by the foot is regulated by the weight of the mace, the number of impacts and the number of passes, which can vary between 200 and 300 m · t / m², while in the standard dynamic compaction it is between 100 and 300 m · t / m². Execution production rates are also usually higher with this system, ranging between 500

and 800 m² / day. The maximum depth of treatment is between 2.5 and 7 m, depending on the type of soil, level of saturation in water and temporary separation between actions at nearby points. In cohesive soils, the addition of gravel is necessary for the improvement of the treatment.

The surface of the mesh, the sequences of the passes and the spacing, must be determined previously at the beginning of the works, since it depends on the type of soil, the depth of the material to be compacted and the location of the water table.

The needs and requirements of the execution rig are the following:

- Work platform minimum headroom 14 m
- Rig length 9,45 m
- Rig width 4 m
- Weight the Rig 65 t
- Weight of the hammer 9 t
- Maximum height of fall of the mace 1,2 m
- Blows per minute 40-60 golpes
- Diameter of the tamper 1,5 m



Rapid Impact Compaction (RIC)



Turbot fish farm. La Coruña, Spain

Tunneling

Assembling an EPB machine in the launching shaft

Tunneling

TUNNELING

MICROTUNNELING

INTRODUCTION

In the field of microtunneling Terratest is one of the European leaders, throughout our owned company Eurohinca, providing its own Tunnel Boring Machines and a wide experience in all kind of soil conditions and applications.

T.B.M. is the abbreviation of Tunnel Boring Machine and his definition is equipment capable of digging tunnels to complete section. To restrict a bit this definition we can be divided TBM in several classifications:

- Full face support TBM: TBM able to control the pressure in the front during the excavation. This type of machines can work under cities and cross road, railways, etc.
- Open shields: For stabilize grounds and without any civil construction in the surface.

Depending on the tunnel support

- Segment lining: Can be use in all type of ground and with all type of TBM.
- Metal roof truss: Used only in rock ground and with gripper TBM.
- Pipe jacking: For tunnels with diameter smaller than 3 m.

Depending on the extraction method

- EPB Shield: Extraction with endless screw conveyor.
- Hidroshield: Extraction with pumps.
- Rock TBM, double shield and open shields: Extraction with conveyor belt.

ADVANTAGES OF TRENCHLES TECHNOLOGY

Tunnels<>Trench

- Less effect on existeng services.
- Lower environmental impact.
- Minimizes spoil and waste generated.
- Compact instalation.

TMB<>Mining

- Increased security for workers. (Works inside a shield)
- Less risk of surface settlements. (Excavation Front is supported)
- Higher outputs. Minor delays.
- Reduced impact on ground water level.

TYPICAL APPLICATIONS

- Server and water supply networks. Collectors.
- Crossings under existing services. (road, streets, railways, rivers, airport runways, golf courses, etc.)
- Sea outfalls. Water release or intake.
- Tunnels with tunnel boring machines.
- Underground corridors.
- Gas and oil pipelines. Drainage and evacuation systems.
- Pipe arching for road or railway crossings.
- Steel pressure pipes.
- Water intake and release for fish farm or desalination plants.
- Water waste pipe and intakes in reservoir dam.



EPB control panel
 Assembling an EPB machine in the launching shaft
 Hydro shield machine in port after an outfall drive
 Breakthrough of Hydro shield in reception shaft

CLOSED FACE TUNNEL BORING MACHINES

EPB SHIELDS

The EPB Shields (Earth Pressure Balance) are TBM machines that support the tunnel face with the pressure applied by the excavated soil located inside the excavation chamber; the controlled extraction of the soil from the excavation chamber by means of a variable speed auger allows the adjustment of the pressure applied to the tunnel face.

The excavated material is transported to the launching shaft by conveyor belts or muck wagons.

The EPB Shields were initially designed to bore soft, cohesive

ground, (mainly clay), but with the use of foam and polymers it is possible to bore other type of soils as sand or even rock.

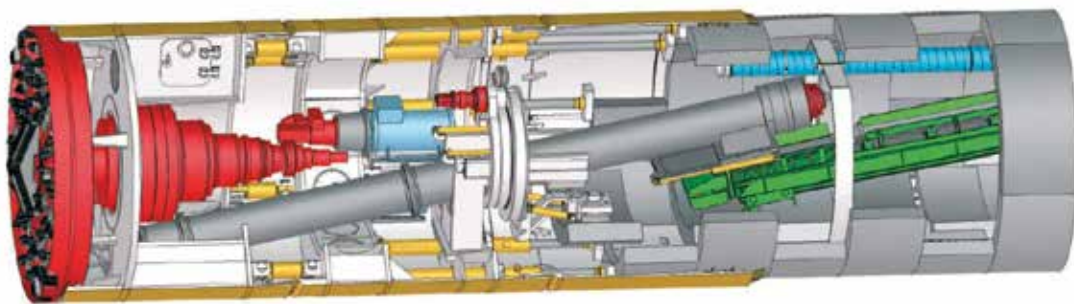

HIDROSHIELDS

The TBM mix shield, or hydro shield, supports the tunnel face by the pressure of the bentonite suspensions injected in the excavating chamber and mixed with the excavated material.

This mixture is crushed in the excavation chamber and is evacuated by hydraulic pumps to the launch shaft where a separation plant separates the excavated material from the bentonite suspension.

The Hidro shield TBM can be used in almost all type of ground, and performs well in sand, rock, under ground water level (Sea outfalls) and

it is specially indicated for small diameters.

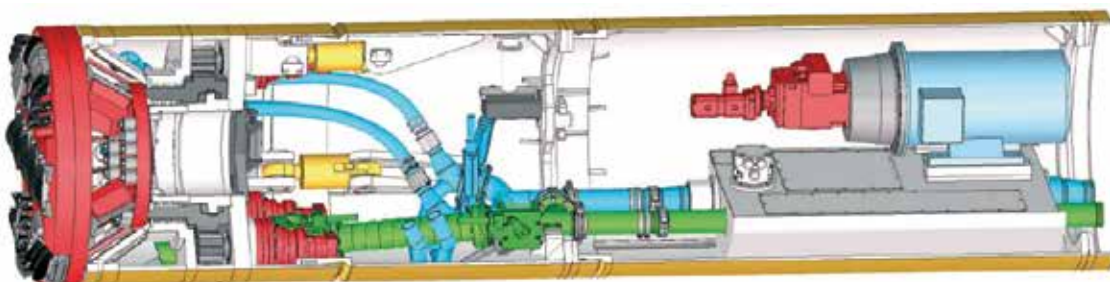

- Roadheader in open shield
- Front face in an excavator open shield
- Range of ground per TMB
- Rock tunnel face

OPEN FACE TUNNEL BORING MACHINES

OPEN SHIELDS - ROADHEADERS OR EXCAVATION

Open face shields allow a visual contact to tunnel face. The front is excavated by powerful roadheaders or excavators. The extraction of the excavated material is made by muck wagons pushed by locomotives or winches.

It is an economic and optimal solution for non urban with cohesive soils and above ground water level.



TBM CHOISE

A detailed and comprehensive geotechnical study (including ground investigation, ground water level, type of soil, resistance to simple compression, rock abrasivity, etc...) is the basis for the selection of the appropriate TBM equipment and excavation method.

With complete information it is possible to define the most suitable TBM, cutter head configuration and tools, characteristics of the lining, the alignment of the tunnel, and also, if necessary, preventive measures to be taken, monitoring systems, etc...

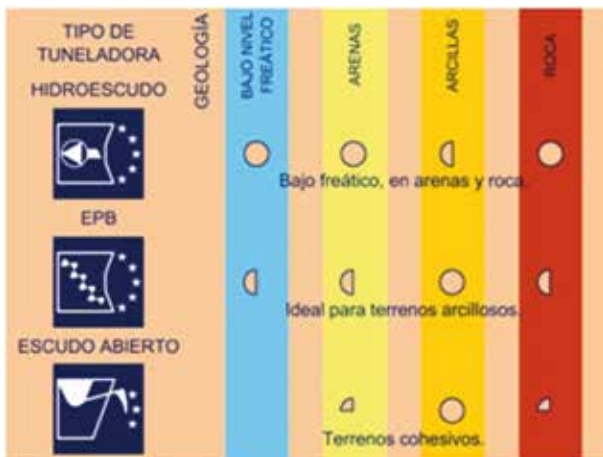

Segments in the Back up of the T.B.M.
 Bentonite injection points in pipe jacking tunnel

Last lining ring in the reception shaft
 Jacking frame in launching Shaft
 Downloading a jacking pipe

TUNNELING LINING

SEGMENTAL LINING

Precast concrete elements that are installed inside the tail skin shield of the TBM, building a complete ring that constitutes the final tunnel lining.

The thrust of the machine is made on the last ring installed: this allows to excavate great lengths and curved tunnels alignment.



PIPE JACKING

Prefabricated pipes (concrete, steel, etc...) that form the lining of the tunnel and are installed and from the launch shaft pushing forward the TBM to the ending shaft.

To reduce the friction between the pipe and the ground during the jacking phase bentonite is injected in the overcut. Intermediate jacking stations are necessary for long distances.

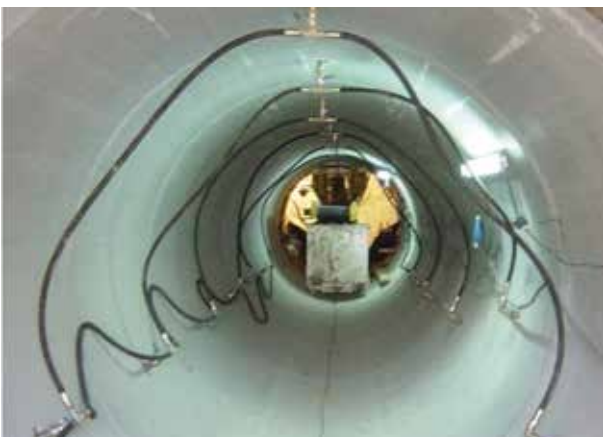

PIPE UMBRELLA

Support of the gallery by means of forepoling

The method consists of inserting steel tubes inside sub-horizontal holes made ahead of tunnel's face. Structures in the form of pre-shaped arc are obtained in this way as support for the excavation. This system finds its ideal application in heterogeneous loose soils containing boulders and large blocks of rock (debris of avalanche). The installation of these tubes is done by means of special rigs who are very stable and are equipped with long mast. The machine is placed in the center of the arch and only the mast is moved in any position of perforation, without moving the machine itself. The drilling can be done directly with the steel pipe or dragging the same within an outer protective pipe or using a down-the-hole hammer placed inside of the

tube itself. Lengths are possible drilling of up to 30 meters, but the optimum value lies between 14 and 18 meters, in this case one piece tubes without junctions can be utilized. The distance between the tubes depends on static factors and the geology and is generally between 30 and 60 cm. The tube diameter is usually between 100 and 180 mm. The tubes are usually fitted with valves and are cemented by the introduction of mechanical single or double packer. Possible deviations of drilling are strongly dependent on soil type.



Metro Warsaw Ground Freezing, Warsaw, Poland
Ground Freezing

GROUND FREEZING

Ground consolidation by means of freezing

Freezing as a method of soil immersed into water is a technique known for several decades in the field of geotechnical engineering. Ground freezing can be achieved by the direct (liquid nitrogen) or indirect method (brine). For both systems thermometric data points, placed inside thermometers distributed within the volume to be frozen, allow an indirect control on the formation of the frozen structure.

In the direct method, nitrogen (close to the atmospheric pressure is liquid at a temperature of about -196°C) circulates in closed metal pipes causing a thermal shock in

the groundwater surrounding the tube itself. Using liquid nitrogen it is possible to freeze the pore water present in a cylinder of soil of about 1 meter diameter within 3-4 days. The liquid nitrogen is distilled from the air and is transported and stored on site in special refrigerated tankers. Once used, the nitrogen is dispersed into the air again as gas.

In the so-called indirect method, brine (a solution of calcium chloride in water) is cooled by means of an electric refrigeration (chilling) unit at temperatures of -35°C - -40°C and is circulated in metal tubes placed in the soil (freezing pipes) returning after to the chilling unit to be cooled. In this case it will take about 3-4 weeks to freeze the water present in a cylinder of soil of about 1 meter in diameter. Also in this case the circulating system must be closed, it is essential to avoid any leakage of brine into the ground.



Gavilanes landfill. Madrid, Spain
Sealing of landfill

ENVIRONMENTAL WORKS

TERRATEST GROUP can respond adequately to new environmental challenges that are posed, and has specialized media, knowledge and technology to carry out activities in sectors as diverse as the oil industry, mining, waste management, civil infrastructure, tunnels, ports, power generation and distribution, and water supply, among others.

Geotechnical and environmental hydrogeology

TERRATEST GROUP has a team of experts, combining classic and new geotechnical disciplines of applied hydrogeology and environmental management, to offer a wide range of solutions in civil engineering, oil industry, mining, groundwater resources, construction, etc.

Contaminated soils and aquifers

TERRATEST GROUP has the most effective technologies for the remediation, removal and/or confinement of contaminated soils and groundwater, which are combined according to a strategy aimed at reducing costs and environmental risks. We also provide professional engineering services and technical assistance, to carry out characterization studies and risk analysis.



San Juan de Mambliga Dams. Burgos, Spain
Construction and waterproofing of dams for water regulation and storage

Urban and industrial landfills

TERRATEST GROUP offers the best available techniques for performing the work of waterproofing of landfills for municipal and industrial waste. Also we provide research services as location, environmental impact, design and drafting of projects, and control and environmental monitoring.

Sealing and degassing of landfills

The closing and sealing of landfills is aimed at reducing the environmental impact of final disposal of waste on the environment, ensuing isolation conditions in time to prevent contamination of soil and ground water, and the emission of gases and odors to the atmosphere.

In the case of municipal waste landfills, are particular relevant, the actions of degassing and energetic use of biogas generated.

Water reservoirs (Dams)

TERRATEST GROUP has an extensive curriculum of construction dams for water regulation and storage. It is waterproofed with geomembranes infrastructure to ensure that no seepage into the ground, that preserve the water quality to its further use: drinking water, irrigation, industrial, aquifer recharge, etc.

Impoundments Waste

A lot of impoundments for the storage of mine tailing, industrial and leachates has been constructed by TERRATEST GROUP, through the combination of artificial mineral barriers and geomembranes, complying with safety standards and containment to avoid environmental contamination.



ENGINEERING DESIGN

TERRATEST has a technical department consisting of a multidisciplinary team of senior engineers, highly qualified with extensive experience in many fields, including geotechnical, structural calculations (metal and concrete) and special foundations.

Our aim is to provide practical, cost effective and value engineered solutions. We also offer design and build solutions to meet each project's specific requirements.

The technical department of TERRATEST uses special, powerful, last generation software, in the field of geotechnical engineering (both in-house developed and acquired), which allows the best of both worlds for each project.

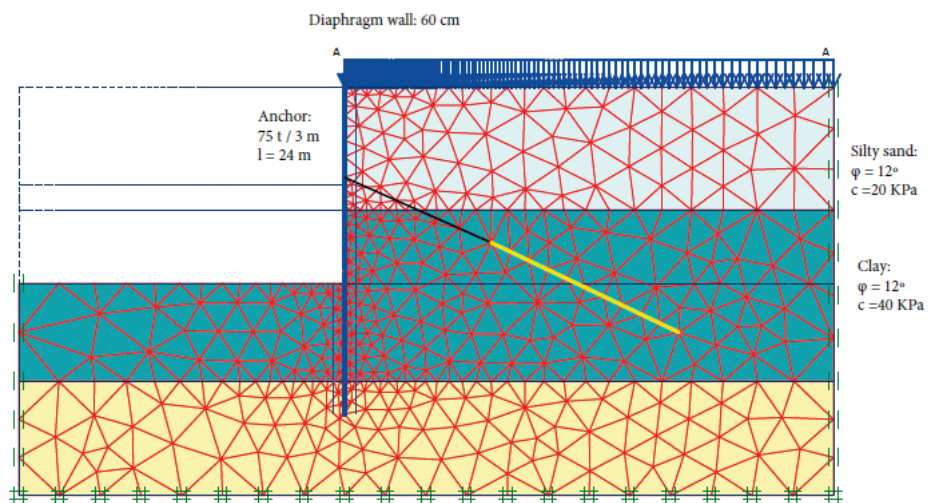

Simulation of a failure load of a single pile by the Finite Element Method

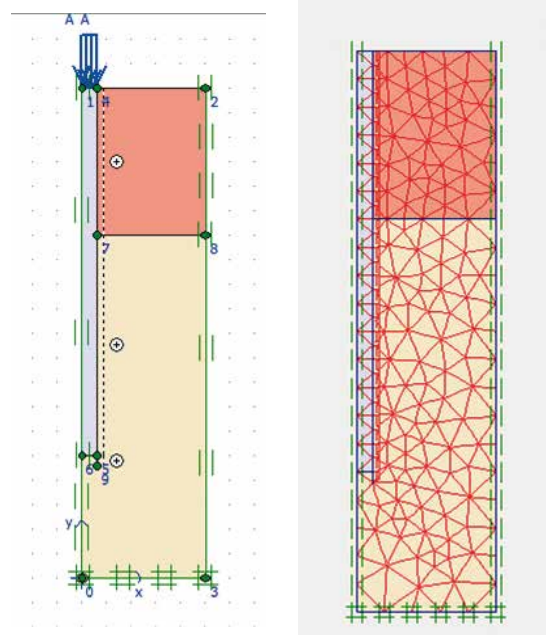
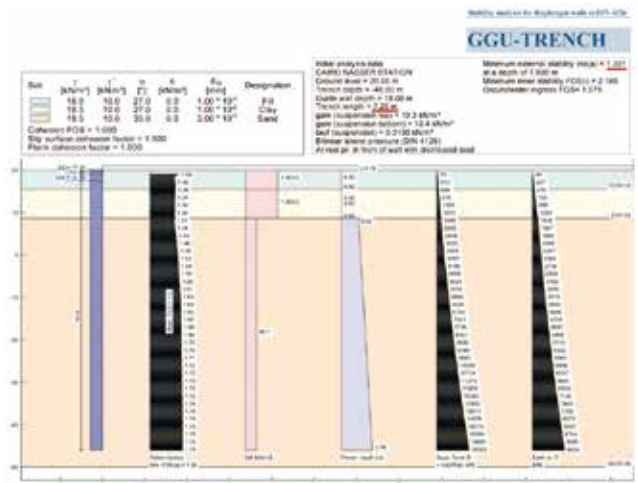

The utilization of these software tools is focused on the optimization of our projects, to give the best service to the client.

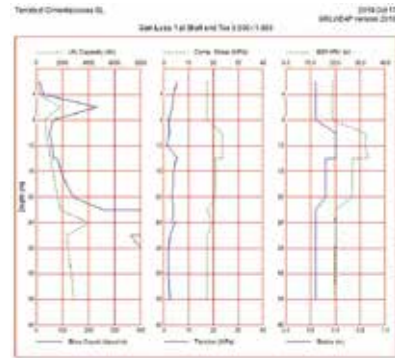
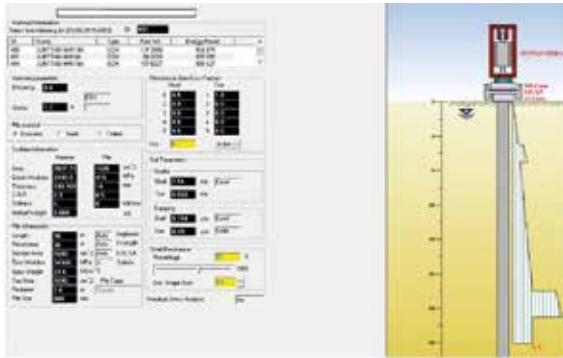

Driveability analysis to study the driving process of piles, metal profiles, etc

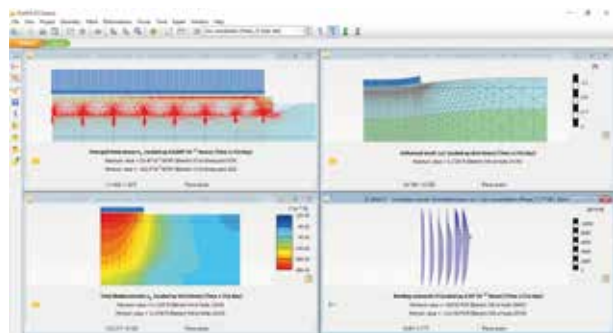
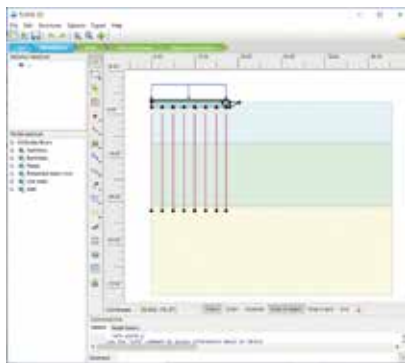

2D Finite element analysis for de evaluation of settlements and soil stresses

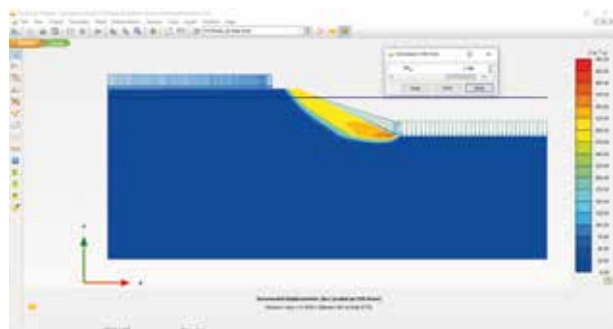
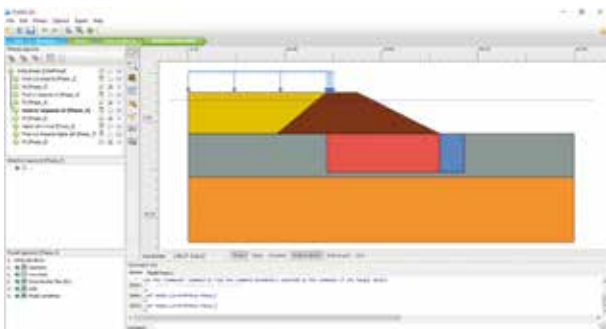

2D Finite element analysis for de evaluation of slope stability in embankments with soil improvement

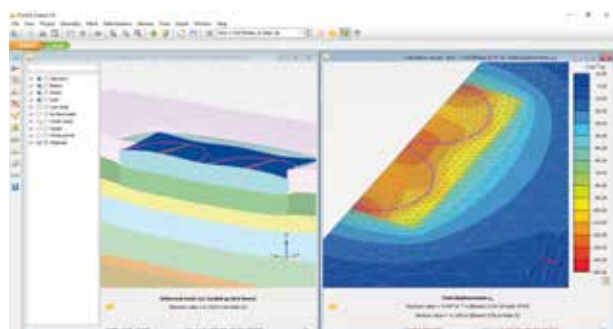
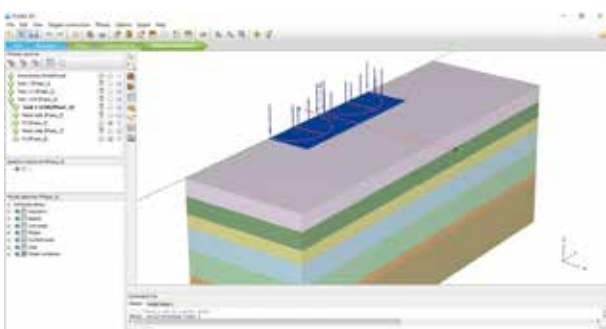

3D Finite element analysis to study the behaviour of two tank foundation

References



Barcelona Subway, Line 9. Barcelona, Spain
Trench cutter





Metro Quito, Ecuador
Diaphragm Walls, Bored Piles and Jet Grouting



Railways and Metro References

More than 500.000 m2 of Diaphragm walls carried out by means of Trench Cutter



Barcelona Subway, Line 9. Plaza Sanllehy, Barcelona, Spain
Trench Cutter





La Carolina Station, Metro Quito, Ecuador
Diaphragm Walls, Bored Piles, Jet Grouting and Compensation Grouting



North Subway, Stretch 1A. Madrid, Spain
Bored Piles and Diaphragm walls



Mónaco Launching Pit, Metro Quito, Ecuador
Diaphragm Walls, Bored Piles, Jet Grouting and Compensation Grouting
Barcelona Subway, Line 9. Torrassa railway station. Barcelona, Spain
Trench Cutter



Railways and Metro References

Madrid-Barcelona-France Border High Speed Railway, Spain
Bored Piles



Metro M2 Lausanne, Switzerland
Steel Pipe Umbrellas-Jet Grouting
Sodermalm Tunnel. Sweden
Tunneling





City Metro Tunnel Karlsruhe Manchette Pipe Grouting
Grouting



Ave Sants-Sagrera Tunnel, Barcelona
Grouting and Fore-Poling



Saint Martin pass. RHÔNE-ALPES - FRANCE
Micropiles





Trans-Gambia Bridge And Cross Border Improvement, Soma, The Gambia
Driven Steel Piles





Forth Crossing Bridge. Edinburg, Scotland
Off Shore Jet Grouting



Roads References

A9 Turtmann Cut and Cover Tunnel
Anchored an Jet Grouting Slab
Kurortni Sochi Beltway, Rusia
Tunneling



Aerovía, Guayaquil, Ecuador
Precast Piles



Roads References

Plaza de les Glòries, Barcelona
Diaphragm Walls,



Hubertus Tunnel. La Haya-Amsterdam Motorway, La Haya, Holland
Ground Freezing



Roads References

Connection of the Airport with the Maritime Port, Gdansk, Poland
Diaphragm walls and Jet Grouting



International Bridge over Danube River, connecting
the cities Vidin (Bulgaria) and Calafat, Romania
Bored Piles



Puente de las Americas Rehabilitation, Panama City, Panama
Ground Anchors



Luis Cabrera Motorway Extension, Mexico City, Mexico
Bored Piles



Road RN6 Tanaff Kolda Lot 1, Lot 2 and Kolda Bridge, Senegal
Bored piles





El Sing Ravine, Alcoy
Cmpaction Gouting



CH El Quimbo, Gigante, Colombia
Grouting, Drains and Instrumentation



Hydraulic Works References

Quay Extension, Tulcea Port, Phase 4+5, Romania
Bored Piles



Quay Extension, Tulcea Port, Phase 7, Romania
Bored Piles



Hydraulic Works References



Botafoc Pier. Ibiza Port, Spain
Bored Piles





Projet APM Terminal Medport Tanger (TM2)
Bored Piles



Hydraulic Works References

Aqaba New Port Phase II (Jordan)
Diaphragm Wall with Hydrofraise



Bridge Foundation in Maliaño Pier. Santander Port, Spain
Bored Piles



Hydraulic Works References

First docking frontline prolongation for large ships. Botafoch Dock. Ibiza, Spain

Bored Piles

Front face in an excavator open shield

Tunneling



On Shore and off Shore Tunnels. Desalination Plant, Sorek, Israel
Tunneling





Logistic Storage Warehouse. Cabezuela Dock. Puerto Real (Cádiz)
GEOPIER® Systems





Wilmington Sports Complex - Wilmington, DE
GEOPIER GROUTED IMPACT® SYSTEM





Ymca Mixed-Use - Raleigh, NC
GEOPIER GROUTED IMPACT® SYSTEM



Buildings References

Gas Natural Combined Cycle Power Plant, Spain
Precast Piles



Corte Inglés Mall, Tarragona, Spain
Diaphragm walls



Buildings References

Coal Power Plant. Medusa Project, Spain
Bored Piles



Residential Building Sotogrande, Cádiz, Spain
Diaphragm walls



Buildings References

Edi Wind Farm, Juchitan de Zaragoza, Oaxaca, Mexico
Stone Columns





WTC Constant, Romania
Bored Piles



2ND Water Power Plant of Hongrin Léman
Rock Grouting



Buildings References

Business Plaza, Guayaquil, Ecuador
Diaphragm walls



Talara Refinery Modernization Project. Peru
Precast Piles

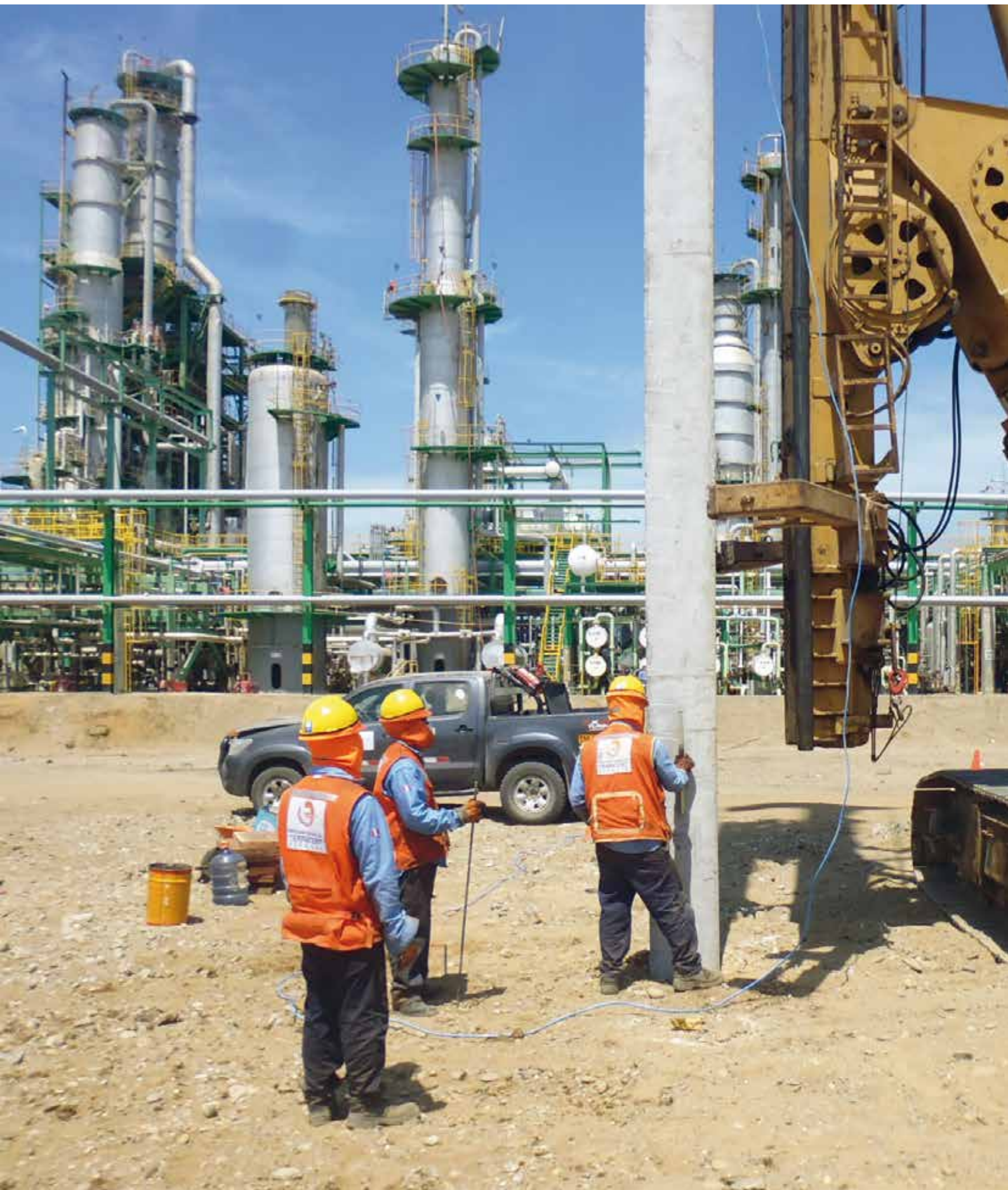



Mahou-Calderón Area, Madrid
Retaining Walls



Buildings References

SUNTI Golden Sugar Estate, Mokwa,
Niger State, Nigeria
CFA Piles





Sede FIRS. Abuja, Nigeria
Bored Piles



Burkina Faso Embassy in Abidjan, Ivory Coast
Bored piles



References

Marina La Farola Málaga Harbour, Spain

Diaphragm walls and Anchors

Foundations for a new Drawbridge. Santander Harbour, Spain

Bored Piles

Juan Gonzalo Dock. Huelva Harbour, Spain

Compaction Grouting, Jet Grouting

El Prat Dock. Barcelona, Spain

Stone Columns

Coal warehouse. La Coruña, Spain

Bored Piles

Silos. Tarragona Harbour, Spain

Precast Piles

New fish market. La Coruña, Spain

Micropiles

Avilés Estuary. Asturias, Spain

Bored Piles



Málaga Subway, Lines 1 and 2. Málaga, Spain

Diaphragm walls

Noth Subway Stretch 1C and 2A. Madrid, Spain

Diaphragm walls

Madrid Subway, Line 3. V. Bajo railway station. Madrid, Spain

Diaphragm walls

Barcelona Subway, Line 9. Barcelona, Spain

Diaphragm walls

Málaga Subway, Line 1. Málaga, Spain

Diaphragm walls

Noth Subway Stretch 2B. Madrid, Spain

Diaphragm walls

Madrid Subway, Line 3. C. Los Ángeles railway station. Madrid, Spain

Diaphragm walls

Barcelona Subway, Line 9. Barcelona, Spain

Diaphragm walls





TERRATEST

Juan de Arespacochaga y Felipe, 12
E28037 Madrid
Tel.: +34 914 237 5 00
Fax: +34 914 237 5 01
E. Mail: terratest@terratest.com
www.terratest.com



Member:

